

Resetting Drop-In Decoder To Original Factory Settings

Using The T9000 Throttle

Follow these steps to reset your AirWire Decoder to its original factory settings. Remember that any Drop-In decoder sharing the frequency will also be reset. Turn off all other nearby decoders to avoid this problem.

Turn on the throttle.

Push the SPR key then the SEL key to enter the Service mode.

One at a time, push the following keys: *, 8, *.

One at a time, push the following keys: #, 1, 3, 5, #.

Listen for the decoder to beep signifying the command has been sent.

Push the SPR key to return to normal operation or cycle the throttle's power switch..

At this time, the decoder has been reset to factory defaults. It will be on address 3. Set the throttle to address 3 to confirm that decoder has been reset.

Using The RF1300 Throttle

Follow these steps to reset your AirWire Decoder to its original factory settings. Remember that any Drop-In decoder sharing the frequency will also be reset. Turn off all other nearby decoders to avoid this problem.

First, turn *off* throttle's power switch.

Next, push **and hold** the 9 key. While holding down the 9 key, turn on the power switch.

Release the 9 key. Notice the direction indicators are alternately flashing signifying the throttle is in the programming mode.

One at a time, push the following keys: *, 8, *.

One at a time, push the following keys: #, 1, 3, 5, #.

Listen for the decoder to beep signifying the command has been sent.

Turn off the throttle to exit programming mode.

At this time, the decoder has been reset to factory defaults. It will be on address 3. Reset your throttle to address 3 to confirm that decoder has been reset.

See the Drop-In Decoder Users Guide for much more information regarding all the ways to setup your new decoder and locomotive for optimum performance.

© 2010 By CVP Products – All Rights Reserved
May Not Be Duplicated Or Reproduced Without Permission
P.O. Box 835772 Richardson, TX 75083-5772

972-238-9966 10AM- 4PM Central Time, Weekdays www.cvpusa.com

November 2010 r03d

AirWire900®

GP38 Drop-In™ Decoder

Installation Guide

USA-Trains GP38-2 Disassembly

Battery And Smart Charger Preparation

GP38 Drop-In™ Decoder Installation

Quick Start Guide

How To Use This Manual	2
Drop-In Decoder Familiarization	3
Battery Pack and Battery Charger Preparation	4
USA-Trains GP38-2 Disassembly Instructions	6
Installing the Optional Phoenix P8 Speaker and Interface Jack	14
Mounting the P8 Module	15
Mounting the GP38 Drop-In Decoder.....	16
Initial Operation Check Before Reassembly	17
Setting the Frequency Selector Switch	18
Quick Start Guide.....	19
Detailed P8 Hookup Diagram and Operating Notes.....	22
Changing The GP38 Drop-In Decoder Address.....	23
Resetting The GP38 Drop-In Decoder To Original Factory Settings.....	Back

AIR WIRE®
900

Contents
GP38 Drop-In Decoder
Battery Pigtail
Charger Pigtail
This Manual

Drop-In, AirWire, AirWire900, AirWire name and logo are registered trademarks of CVP Products © 2010

How To Use This Booklet

The booklet has 2 major sections.

Locomotive Disassembly and AirWire Drop-in Decoder Installation

This section starts with the simple task of attaching the appropriate sockets and plugs to the battery and the battery charger. Step-by-step instructions then show how to disassemble the USA-Trains GP38 diesel locomotive. Once the locomotive is opened up, the installation of the Phoenix P8 sound module is described followed by the rather simple task of installing the Drop-In decoder. With the installation done, a quick checkout is run and then the locomotive is reassembled.

Quick Start Instructions

This short section describes how to control the features of the GP38 locomotive using the AirWire throttle. In this section you will find the "cheat sheet" listing the throttle function key assignments for both the locomotive and P8 sound effects.

Miscellaneous Items

Some useful items related to changing the Drop-In decoder address and how to reset the Drop-In decoder to its original factory settings finish out this book.

See The Drop-In Users Guide For Applications Tips

Since this manual is used during installation only, and it is specific to the GP38-2 locomotive, there is a second users guide. This second users guide will have all of the items related to fine tuning and performance optimization as well as some interesting application tips.

Recommended Optional Items - Phoenix P8 Sound Module & Interface Adapter

The Drop-In Decoder is designed to work with the Phoenix P8 sound module. The P8 module requires their interface adapter to setup the P8 functions. If your installation will not have sound, then you may ignore all references to the P8 sound module

Throughout this manual, all references to the battery charger and battery are referring to the CVP Products' 14.8V Lithium battery pack and the Tenenergy brand smart battery charger.

**A smart person reads instructions.
A genius follows instructions.**

Changing Drop-In Decoder Address

Using The T9000 Throttle

The original factory setting for the decoder address is 3. You can change the address to any number from 1 to 9999. We recommend using the locomotive cab number. If you don't have a lot of locomotives, perhaps the last digit of the cab number's is sufficient. What ever is used, make sure it is unique. Keystroke examples are done using CVP's AirWire T9000 throttle first, followed by the RF1300 throttle. See the appropriate throttle instruction manual if you are using a different type of throttle.

Changing the Locomotive Address.....CV1

Range is 1 to 9999 when using an AirWire throttle.

For this example, the address will be changed from 3 to 7679. First turn on the decoder power switch. Using the T9000 throttle, enter the following keystrokes to set the new address:

SPR	selects service mode
SEL	confirms that service mode is wanted
,1,	tells which CV is to be changed
#,7,6,7,9,#	loads the number of 7679 into the selected CV
SPR	exits service mode

When the final # is pressed, the locomotive decoder is sent the information. The decoder acknowledges this with both a momentary pulse of the motor along with the several beeps.

Press SPR to exit the service mode, or simply turn the throttle power switch off then back on. Either way exits the service mode.

Enter the new number, 7679, into the throttle and verify the locomotive operates along with the P8 sound system if it is installed.

Using The RF1300 Throttle

The original factory setting for the decoder address is 3. You can change the address to any number from 1 to 9999. We recommend using the locomotive cab number. If you don't have a lot of locomotives, perhaps the last digit of the cab number's is sufficient. What ever is used, make sure it is unique.

First, turn *off* throttle's power switch. Then push **and hold** the 9 key. Then, while holding the 9 key down, turn on the power switch. Now release the 9 key. Notice the direction indicators are alternately flashing signifying the throttle is in the programming mode.

One at a time, push the following keys: *, 1, *

Then, one at a time, push the following keys: #, 7,6,7,9, #.

Listen for the decoder to beep signifying the command has been sent.

Turn off the throttle to exit programming mode, then turn it back on.

Enter the new number into the throttle, # 7,6,7,9,# and verify the locomotive operates along with the P8 sound system if it is installed.

Phoenix P8 Hookup Diagram



This is the Phoenix P8 hookup diagram. The wires are somewhat stiff and fragile. Don't subject them to a lot of unnecessary flexing.

If not using a P8 speaker, cut off the connector on the two brown speaker wires and solder the wires directly to the speaker.

The sockets are polarized and can only be completely inserted when oriented correctly.

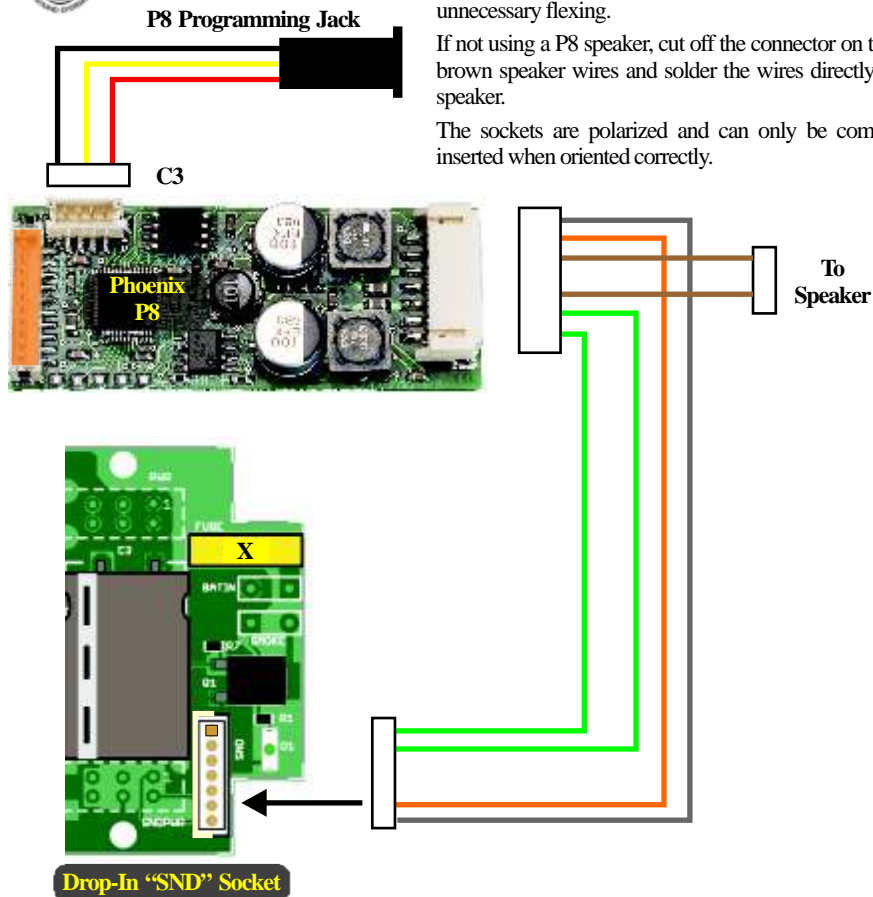

The Drop-In decoder has a dedicated power switch for the P8. The P8 power switch is independent of the Drop-In decoder power switch. When turned on, the P8 is connected directly to the battery. The P8 can be powered while the Drop-In decoder is not.

Don't forget this fact when you turn the sound volume down low or off. Even if off, the P8 draws power from the battery and it will not automatically turn off.

Always use the power switch to shut off the P8.

P8 Address Setup

The Drop-In decoder sends DCC commands to the P8 on address 3. There is no need to change the P8 address from the factory setting of 3.

Phoenix P8 Sound Decoder Setup - See The Drop-In Decoder Users Guide

The P8 is a versatile sound decoder with many options and selections. However, there are selections that must be made to achieve the best results with the AirWire Drop-In decoder.

Detailed P8 setup instructions are contained in the Drop-In Decoder Users Guide. Also, be sure and see the P8 manual and read the help screens that are part of the Phoenix programming software.

GP38 Drop-In Decoder Familiarization

The additional battery and charger pigtails are not shown here but are included with the Drop-In decoder.

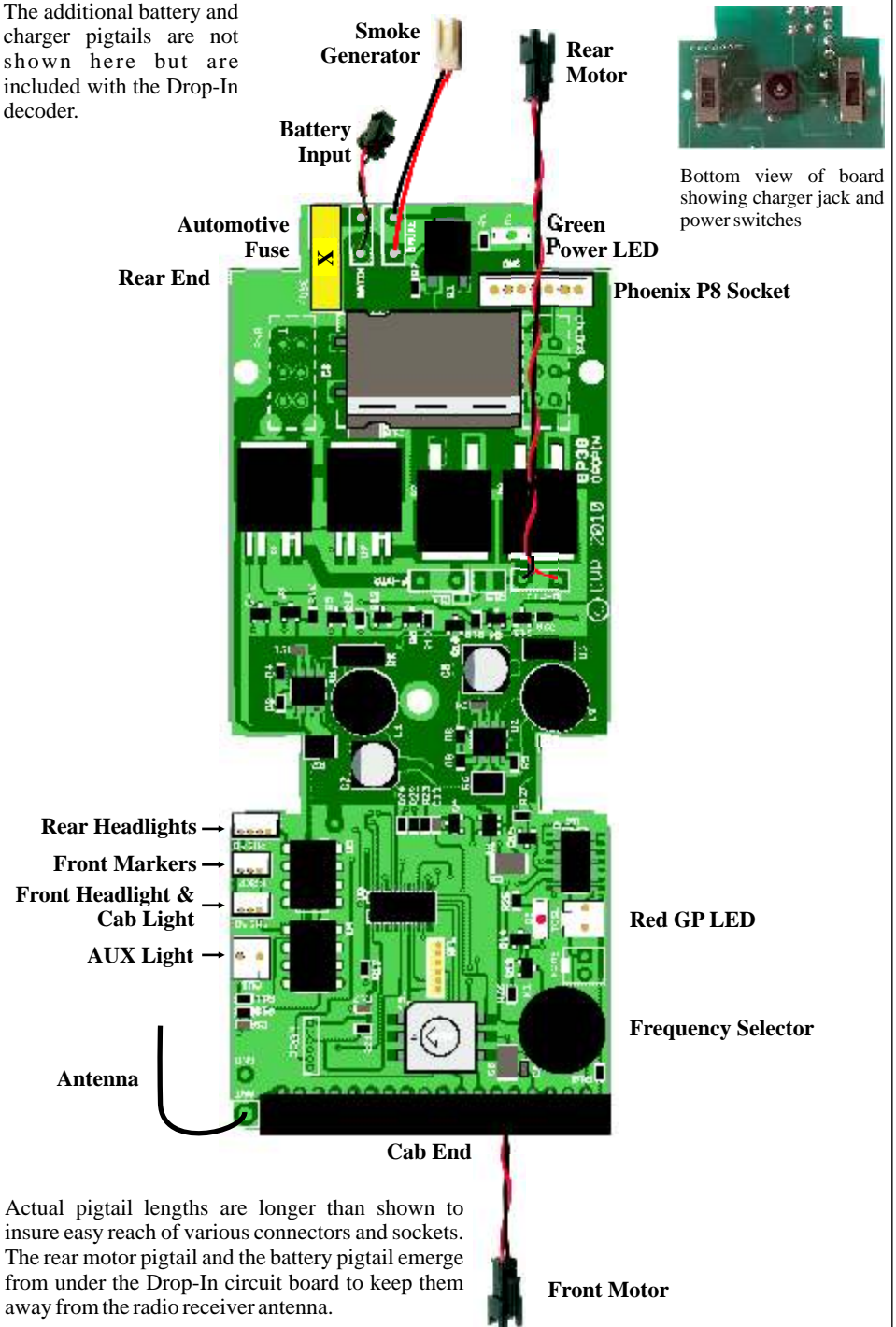

Actual pigtail lengths are longer than shown to insure easy reach of various connectors and sockets. The rear motor pigtail and the battery pigtail emerge from under the Drop-In circuit board to keep them away from the radio receiver antenna.

Attaching Battery Pack Pigtail



Lithium Battery Pack
Actual color of pack may vary



Power Plug Pigtail

WARNING: The CVP battery pack wire ends are insulated with heatshrink tubing. Remove only one piece of tubing at a time and then, only when ready to make the connection to the power plug, NEVER allow the two bare battery wires to touch.

The Lithium battery pack comes with wires that must be connected to the power plug pigtail. The pigtail is included with each Drop-In decoder. This is not difficult and no special tools are needed.

If you are using a different battery, you must properly identify the PLUS wire. If you get the polarity wrong, you will damage the Drop-In decoder and the warranty does not cover this. If you are not sure, seek help - don't guess.

Battery polarity is very important. Incorrect polarity will damage the decoder. This is not covered by the decoder warranty. For the Lithium battery, the plus wire is red. The black wire is minus. For the power plug, the plus wire is also red and the minus wire is black.

Twist the Power Plug Wires Together so they look like the picture. This helps minimize radiated noise. Once twisted together, trim both power plug wires to about 4 inches long. Next, trim the red power plug wire so it is about 1 inch shorter than the black wire.

Remove about 1/2 inch of the insulation from the black wire. Twist the strands together and touch a tiny bit of solder to the twisted wire. This is called tinning and keeps the twisted wires from unraveling.

Remove about 1/2 inch of the insulation from the red wire. Twist the strands together and touch a tiny bit of solder to the twisted wire. This is called tinning and keeps the twisted wires from unraveling.

On the battery, start by trimming the black wire so it is one inch shorter than the red wire. Do not remove the heatshrink tubing on the red wire.

Remove about 1/2 inch of the insulation from the battery's black wire. Twist and tin the wire.

If you are using heatshrink tubing to insulate the solder joints, now is the time to slide a piece over the black wire - either side will work. Otherwise, use electrical tape to insulate each connection. Overlap or twist together the two black wires and solder them together. Once the solder joint has cooled, slide the heatshrink over the connection and heat it up so it shrinks around the connection. Make sure no bare wires are visible.

Remove the heatshrink tubing from the red wire. Don't forget to slide on a fresh piece of heatshrink for use later. Now overlap or twist together the two plus wires and solder them together. Once the solder joint has cooled, slide the heatshrink over the connection and heat it up to shrink it around the connection. Make sure no bare wires are visible. This completes the wiring.

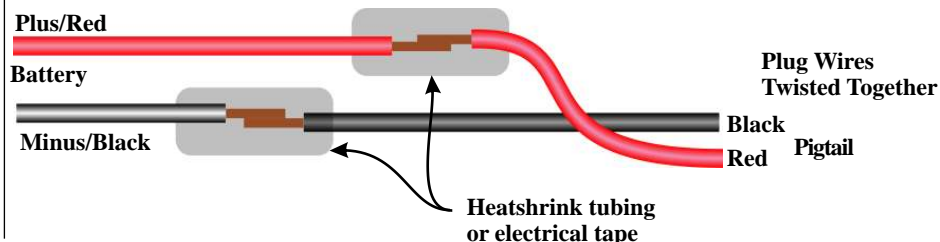

GP38 Quick-Start - continued

Coupler clang is triggered by F3. Trigger means the sound effect is transitory and sounds each time the key is pressed.

Grade crossing horn is triggered by F4. This is a 15 second recording of a complete grade crossing horn sequence.

“AllAboard” station announcement is triggered by F5.

Compressor start up is triggered by F6. The sound effects runs for a few seconds and then shuts off.

Volume Up is triggered with F7. To use this feature, push F7 to begin increasing the overall Phonenix sound volume. When the volume reaches the desired level, push F7 to stop and hold the volume setting.

Volume Down is triggered with F8. This works the same as F7 except the volume will begin to decrease when F8 is pushed. Push F8 again to stop and hold the volume setting.

Caution: if the volume is allowed to decrease to 0 or off, the volume will remain at 0 when the power is turned off. When turned back on, you may think there is a problem with the sound when in fact you simply have to push F7 to raise the volume.

Dynamic Brake is toggled with F9.

Brake release sound is triggered with F10.

Air Pop Valve sound effect is triggered with F11.

Diesel Engine Shutdown is triggered with F12. This will initiate the shut down sequence for the diesel engine. You can manually restart the engine by simply pushing F12 again. Note that if the throttle speed setting is not idle, the diesel automatically restart. This applies when the locomotive is standing still too. Any change of the speed control will automatically restart the diesel engine.

This table shows the combined list of recommended function key assignments for the Drop-In decoder and the P8 sound module. Black is the effect for the Drop-In decoder and red is the effect for the P8.

Throttle Key	Loco Effect -- Sound Effect
0	Toggle Headlights On/Off and Auto-Dim at Idle
1	Toggle Bell On/Off
2	Manual Horn Activation
3	Trigger Coupler Clank Sound
4	Trigger Grade Crossing Horn effect
5	Enable Cruise Control [change speed to disable]
	Trigger Station Announcement
6	Trigger Compressor Sound Effect
7	Volume Up (push to begin increasing, push to stop)
8	Volume Down (push to begin decreasing, push to stop)
9	Toggle Dynamic Brake Sound Effect
*0	Toggle Smoke Generator [2 minute max time on]
	Trigger Brake Release Sound
*1	Toggle Cab Interior and Number Board Lights On/Off
	Trigger Air Pop valve
*2	Toggle Engine Shutdown or Startup Sound Effect

GP38 Drop-In Decoder Quick-Start Guide

The quick-start page assumes the locomotive decoder is on the original factory setting of address 3 and frequency 0. If you have changed either of these, then be sure and use your settings on the throttle. This page also assumes you have used the recommended settings for the P8 sound module. See the Drop-In users manual for details.

Now that the locomotive is reassembled, its time to begin exploring some of its new features and capabilities. These two pages show all of the features using the original factory settings.

As you become familiar with your locomotive performance, you will undoubtedly want to make changes as well as fine tune its operation. Detailed instructions for fine tuning and changes are covered in the next section.

Locomotive Motion Control

Speed and direction are controlled from the throttle. Use the throttle's knob to change speed. To change direction, push the direction key. "Forward" direction is defined as if you were sitting in the locomotive cab.

Cruise control activation is easy. Once the locomotive is running at the desired speed, push F5 to activate cruise control. A beep will be heard when cruise control is activated. To deactivate cruise control simply change the speed or direction. A beep will be heard when cruise control is deactivated. At very slow speeds, you may hear a double beep. This means that the locomotive is going to slow for reliable cruise control so you need to increase the speed slightly and push F5 again.

Locomotive Lighting and Smoke Generator Control

Headlights are toggled on and off with the throttle's 0 key. This is function 0 which we shorten to F0. The headlights automatically switch between front and rear when direction key is pushed.

Cab interior and number boards are toggled on and off with F11. As a reminder F11 is the * key followed by the 1 key on the T9000 throttle. For the RF1300 throttle, F11 requires you to push the # key, then the * key followed by the 1 key.

Smoke generator is toggled on and off with F10. Once turned on, the smoke generator has an automatic 2 minute timeout. However, if the smoke fluid has run out, the locomotive's own smoke generator controller will turn off even if the 2 minute timer has not run out. As a reminder F10 is the * key followed by the 0 key on the T9000 throttle. For the RF1300 throttle, F10 requires you to push the # key, then the * key followed by the 0 key.

Phoenix P8 Sound Effects Control

The table on the next page assumes you have used the recommended configuration file or have set up the P8 to match our recommended settings. These settings are described in the Drop-In decoder operation manual. If you have not yet configured the p8, the sound effects and throttle activation keys will not match and the sound may shut off after only a few minutes of operation. This is normal if the configuration has not been changed - it is not a Drop-In or sound module problem.

Bell is toggled on and off by F1. Toggle means push and release the F1 key to turn on the bell. To turn off the bell, push F1 again.

Horn is activated by F2. This is a momentary activation which means push to turn on and release to turn off. There is an automatic timer tied to the horn activation. Sometimes, when the horn is activated, it does not receive the turn off command. This can be caused by motor noise, distance from the throttle or momentary jamming. To prevent the horn from being stuck on, the Drop-In decoder will automatically shut off the horn.

Attaching Charger Plug Pigtail To Charger

First, open up the charger box. The only items kept are the charger, the power cord, and the spare fuses. All other items are not needed and may be discarded.

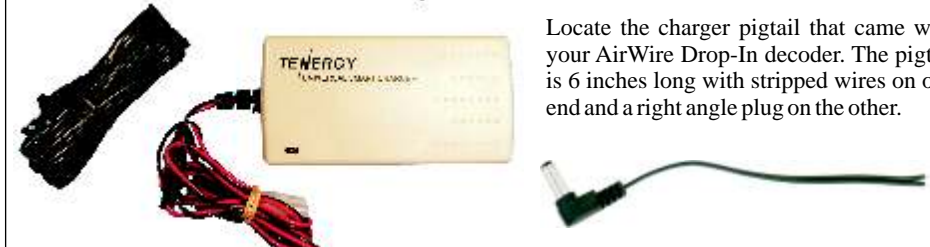

Locate the charger pigtail that came with your AirWire Drop-In decoder. The pigtail is 6 inches long with stripped wires on one end and a right angle plug on the other.

The pigtail needs to be permanently attached to the charger output wires. This is not difficult and no special tools are needed.

Wire polarity is very important and reversing the polarity could damage the charger or the battery or both. On the pigtail, the plus wire is the wire with the white stripe. The minus wire is the solid black wire. The charger uses the conventional red wire for plus and black for the minus wire.

Take the pigtail and separate the 2 wires for about 2 inches. Cut the plus wire so it is 1 inch shorter than the minus wire. Remove about 1/2 inch of the insulation from the minus wire. Twist the strands together and touch a tiny bit of solder to the twisted wire. This is called tinning and keeps the twisted wires from unraveling.

Take the charger wires and split the red and black wires apart for about 3 inches. Cut the minus wire so it is shorter than the plus wire. Remove about 1/2 inch of the insulation from both the black and red ends of the wires. Twist and tin the wires.

If you are using heatshrink tubing to insulate the solder joints, now is the time to slide a piece over the minus wire - either side will work. Otherwise, use electrical tape to insulate each connection. Overlap or twist together the two minus wires and solder them together. Once the solder joint has cooled, slide the heatshrink over the connection and heat it up to shrink the tubing around the connection. Make sure no wire is visible.

Slide a piece of heatshrink over the plus wire. Overlap or twist together the two plus wires and solder them together. Once the solder joint has cooled, slide the heatshrink over the connection and heat it up to shrink the tubing around the connection. Make sure no wire is visible.

Inspect for proper polarity matching and that no bare wire is visible outside the heatshrink tubing. This completes the wiring.

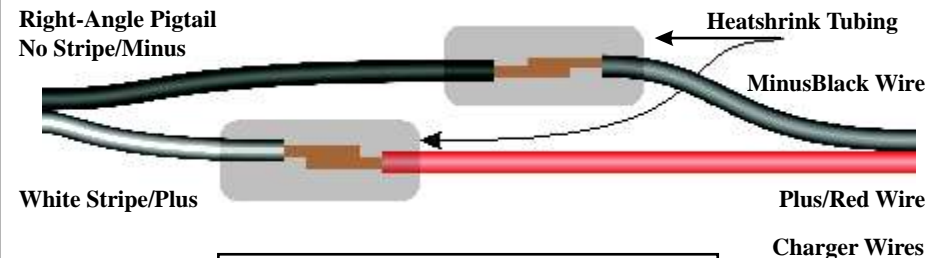

Heatshrink tubing may be ordered from Mouser Electronics. Use 0.25 inch diameter tubing with part number 5174-1141. It sells for about \$2 and comes in a 4 foot length. www.mouser.com

USA-Trains GP38-2 Disassembly

Warning: Many parts of the shell and chassis are fragile and easily break. Especially vulnerable are the steps, doors, side-frame assemblies, and cab awnings. Gently pull up and remove the horn assembly if it has been installed. The radio antenna is especially vulnerable so remove it if possible or take care not to break it.



You Must Have The Proper Screwdriver

You must have a thin-shafted, #1 phillips-head screwdriver that is at least 4 inches long to reach the screws. The thin shaft is necessary to fit between the wheel and side frame. This one is from General and has a 4 inch long, narrow shaft with a #1 Philips tip. It is also magnetized which comes in handy for pulling the screws from deep recesses.



A Soft Work Surface Pays Big Dividends

Spread a couple layers of thick towels on your work surface to serve as a cushion for the locomotive. The top of the locomotive is uneven and is unstable when upside down. The towel will help prevent damage should it fall over.

Use a Foam Block To Hold Screws

Take a rectangular sheet of foam and label it B and F to represent the loco's front and back end. As each screw is removed, position it in the foam in about the same location as found on the locomotive.



Total Mounting Screw Count is 16

When all the screws are removed, there will be a total of 16 screws. When you are done, if your count doesn't match, go back and check to see which ones you missed. The next series of illustrations shows the location of the screws and have been numbered for easy reference.

Remove Fuel Tank - 2 Screws

The 2 screws are number below and the black circles are where you will find the screws. Remove the 2 screws, lift off the tank and set it aside for now.



GP38 Drop-In Installation

Common Errors and Fixes

Green Power LED doesn't turn on: Make sure the Drop-In decoder power switch is on. The power LED does not turn on even though the sound module is operating OK.

Red GP LED only has a very slow flash rate: This is your indication that either the radio frequency or the locomotive address is set incorrectly. The small frequency selector could also be off by one click. While the power is on, use a small screwdriver to rotate the selector left or right. If the GP light turns on steady, then you have found the correct frequency.

Make sure everything checks - you don't want to have to take the locomotive apart more than once.

Mount the Fuel Tank

Place the fuel tank near its mounting location on the locomotive. Push the programming jack's connector up through the hole in the floor. Plug in both the speaker connector and the programming connector.

Orient the black radio antenna straight up.

Use twist ties or tie wraps to keep wiring in place and out of the way of all mounting holes. Neatness really counts and will prevent troubles and broken wires during locomotive reassembly.

Closing Up The Locomotive

This will take a few minutes so don't rush - take your time. Bring the top half down onto the chassis slowly and carefully. Make sure all wires are INSIDE the mounting posts. Don't allow a wire to fall on the outside of the post or you risk pinching it when the top half is mated to the bottom half. Also push the smoke generator wires towards the rear of the locomotive. Keep them away from the antenna. Look on both sides of the locomotive. Make sure you can't see any wires. The antenna is usually the one that escapes.

The top half will seat itself correctly and easily when everything is aligned. It is easy to be off by a small amount which will prevent the two halves from mating. Inspect all around. If resistance is encountered, check for wires that may not be inside the mounting posts. The rear headlight wires are usually the ones that slip outside the mounting posts.

Once the two halves are together, turn the locomotive upside down. Once again check for alignment of the two halves. Install the two chassis screws that are hidden by the fuel tank. To start the screw, first turn it slightly counter-clockwise to get it seated in the threads, then turn it clockwise to tighten. Do not over tighten. Then attach the fuel tank. Finish the reassembly by installing the remaining screws.

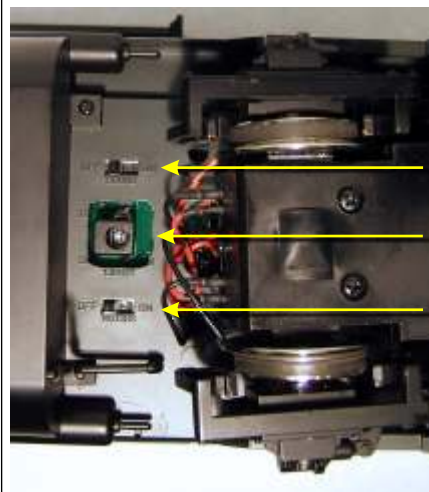

Power Switches And Charger Jack

Phoenix P8 Module Power Switch [shown OFF]

Battery Charger Jack

Drop-In Power Switch [shown in ON position]

Slide Switch Actuator
Towards Truck = ON

Slide Switch Actuator
Towards Fuel Tank = OFF



Set Drop-In Decoder Frequency Selector Switch

Before closing up the locomotive, now is the time to set the decoder's frequency selector. You can always change the frequency at any time but since the locomotive is already open, now is a good time to set it.

The Drop-In Decoder offers the original 8 frequencies plus an additional 8 frequencies making a total of 16 available frequencies. Either the RF1300 or the T9000 throttle can use the original 8 frequencies, numbered from 0 thru 7. **Only** the T9000 throttle can use the 8 new frequencies available on the Drop-In Decoder.

Setting RF1300 To One Of The Original 8 Frequencies - 0 to 7

Use the illustrations to ensure that the throttle/decoder pair have matching frequencies. Notice that the small arrow on the decoder's selector switch points at the frequency number. In the picture to the right, it is pointing at 0. The frequency can be changed at any time and the new setting takes affect immediately. In the drawings below, the white square is the slider portion of the switch.



Note, if using a remote frequency selector, set the selector switch to 0.

Setting T9000 To One Of The Original 8 Frequencies - 0 to 7

Push SEL 1 and enter the numeric number from 0 thru 7 to match the number dialed in at the Drop-In decoder. Push ENT after the number has been entered.

Change Frequencies Carefully - Watch And Count

When changing the decoder's frequency, each click of the switch is followed by a chirp. This tells you that the decoder's frequency has been changed. The little switch's arrow is small so use a bright light, good reading glasses, a jewelers screwdriver and count the chirps as the arrow is moved. Use the GP light as your final check that the frequency and address match before closing up the shell.

Decoder RF1300



Setting T9000 To One Of The New Drop-In Decoder Frequencies - 8 to F

You will be delighted to know that your T9000 is already capable of accessing the new frequencies. The T9000 has an undocumented command that is used to set it to the new frequencies. Note that there is no direct match between the T9000's new frequencies and the Drop-In decoder's switch setting. Be sure to set the decoder first and then enter the frequency on the T9000 throttle. Push SEL 0, enter the numeric number shown below and then push #. Verify that the decoder's GP light turns on.

Decoder



USA-Trains GP38-2 Disassembly

Front End Mounting Screws - 8 Screws

There are two types of screws in this area with one set visible and another set buried deep inside hollow tubes. The circled number is the approximate location of each mounting screw.

The black circled screws are visible. The red circled screws are deep inside hollow columns. The 4 inch long screwdriver must be used to get these out.

The front truck is easily rotated to expose the hollow tubes. Take care not to damage the truck wiring. Be careful and do not damage the side frame's delicate detail.

As each screw is removed, place it into the foam block.

If the screw does not come out of the hole, give it several more turns to insure it has released from the upper shell. It will come out when the shell and the chassis are separated. their access holes.

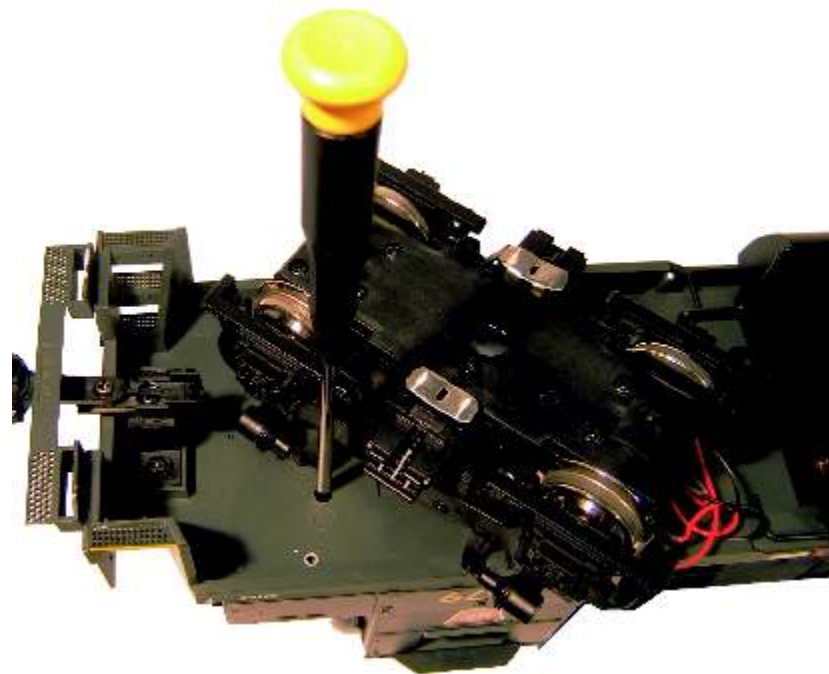
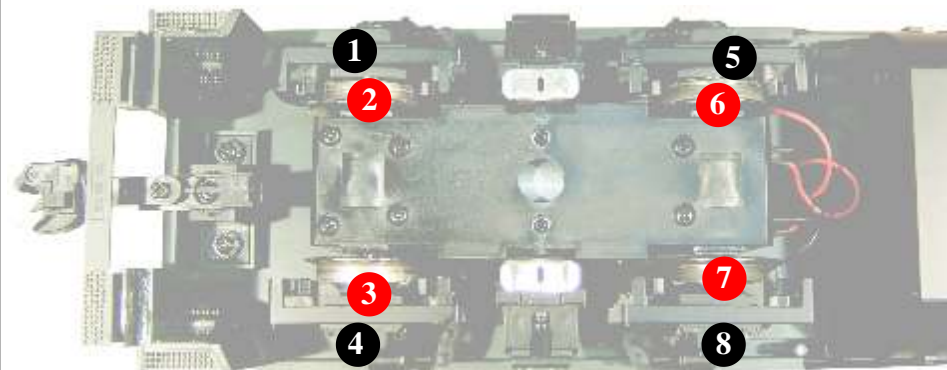

USA-Trains GP38-2 Disassembly

Under Fuel Tank Mounting Screws - 4 Screws

With the fuel tank removed, 4 more mounting screw holes are exposed. Use the long shafted driver to remove these screws, # 11 and #12.

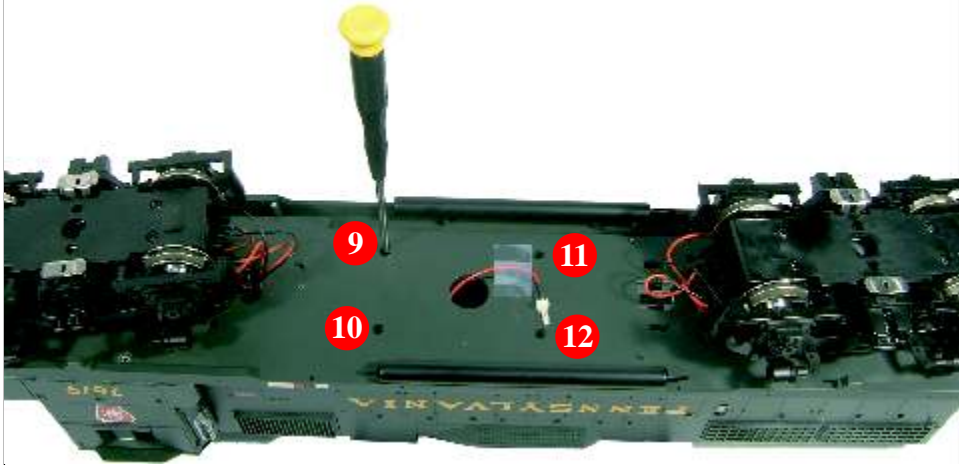

Rear Mounting Screws - 4 Screws

The last 4 screws are under the rear truck. Unfortunately, two of the screws, #15 and #16 are difficult to reach since the truck obstructs the hole. It is the long shaft screwdriver that does the trick. The last two will be save for last.

Let's do the easy ones first. Slightly rotate the truck to expose the hole. Remove the two screws, #13 and #14.

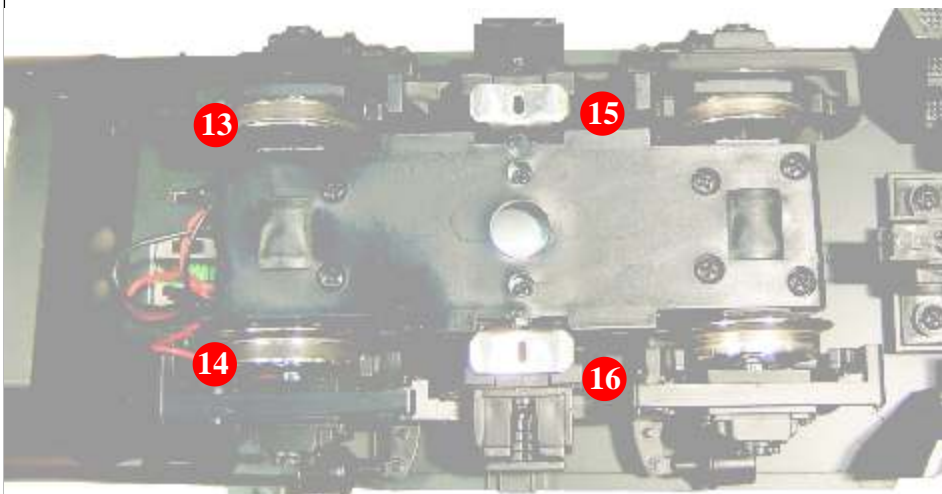

You can remove and discard the track sliders since they are no longer required

GP38 Drop-In Installation

Tidy Up The Wiring

Use the left over twist-ties or miniature wire ties (available from hardware stores) to bundle all wires together. Try to keep the wires away from the antenna which is the 3 inch length of wire near the receiver module.

Some parts of the P8 become hot when operating so don't let the wires lie on top of the P8.

Temporarily Plug In Speaker

Before checking the installation, plug the speaker connector into the P8. Don't bother with the programming jack connector at this time, just the speaker.

The next step will be to check the installation and verify correct operation. A throttle will be required for the next set of steps.

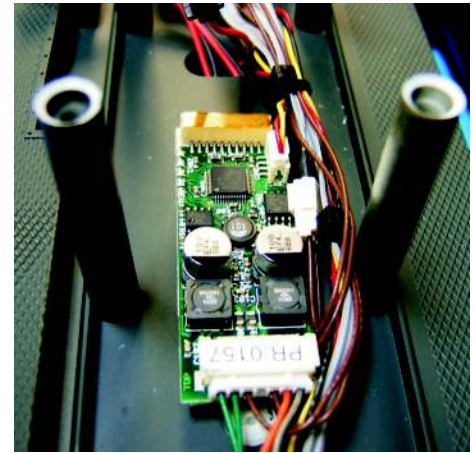

Preliminary Checkout

As delivered from the factory, the Drop-In decoder is set to locomotive address 3. Also, the frequency selector will be set for frequency 0. For this initial test, verify that frequency selector rotary switch's little pointer is pointing at the number 0, and if not, set it to 0. If not, use a small straight slot screwdriver to move the arrow head of the indicator to point at 0.

1. Turn on both power switches on the drop-in. The ON position is with the slide switches towards the cab. The green LED will turn on indicating that battery power is present.
2. You will hear the Phoenix P8 module turn on (if installed). Don't be alarmed if the sound turns off in a minute or so - that is normal and can be changed. Changing this feature will be discussed later.
3. Turn on the throttle and set it for address 3. Also set the throttle to frequency 0. See your throttle manual for how to do this. Now look at the red GP LED - it will be on. It may appear to flicker a bit which is normal. This tells you that the address and frequency are set to match the throttle.

4. Slowly turn up the throttle until you see the motor attempt to move. Verify that both motors turn in the same direction.
5. Turn on the front headlight by pushing the 0 key on the throttle. Change directions and confirm the rear headlight turns on. Push 0 to turn off the headlights.
6. Push the * key followed by the 1 key. This will turn on the cab interior and the number boards. Push * and 1 again to turn them off.
7. Push the * key followed by the 0 key. Listen carefully for the small fan to start running in the smoke generator. Push * and 0 again to turn it off. Since there is no fluid in the generator, be sure and turn it off.
8. If you have installed the Phoenix sound decoder, push the 2 key and the P8 horn will sound.

This concludes the preliminary checkout.

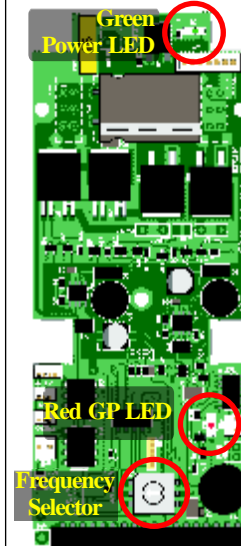

If you intend to change the frequency, do so now before the chassis is reassembled. See the next page for how to do this. And if the frequency is changed, set the throttle to the new frequency and verify the red GP LED turns on before closing up the shell.

GP38 Drop-In Installation

Mount GP38 Drop-In

Before mounting the Drop-In decoder, verify that both power switches are off. The actuators will be towards the front cab when off. Place the decoder onto the mounting posts. Make sure the jack and switches fit through the holes and the board is flush to the mounting posts. Verify that the front motor connector comes out from under the board and is clear of the mounting posts. Use the original 3 screws to mount the board.



Plug In P8 Connector

Start with the white connector from the P8 board. It goes into the matching white socket on the GP38 Drop-In board. It only goes one way, so don't force it.

Plug In Front Motor, Rear Motor and Battery Pack

Plug in the front and rear motor connectors. The wires exiting out the bottom of the board are for the front motor connector. The wires exiting the top of the Drop-In board are for the rear motor connector.

Neatness Counts

There will be a wad of wires and connectors near the battery including the unused pickup connector. Tidy up the area using a bit of tape, plastic tie-wraps or with twist ties. Make sure all wires lie between the tall mounting posts.

Shell Lighting Connectors and Smoke Generator

Move the shell near the chassis and orient it so the cab is aligned with the front of the chassis. Plug in the three lamp connectors using the guide below. Slip your finger under the Drop-In board to prevent excess flexing as the connector is inserted. Press the connector firmly into the socket. The smoke generator is connected with the last remaining plug from the Drop-In. The connector is polarized and only fits in one orientation. Make sure it is pushed all the way down onto the pins.

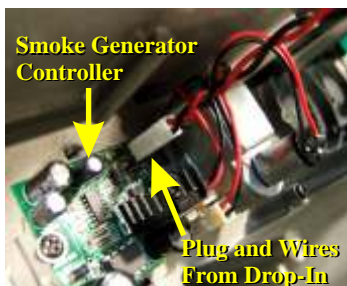
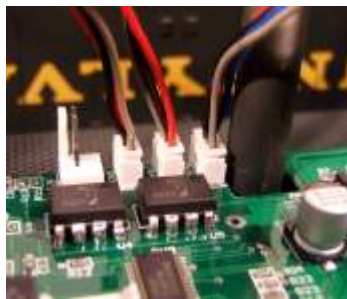
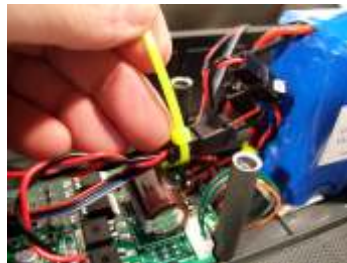
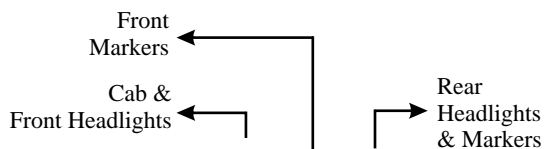

USA-Trains GP38-2 Disassembly

Final 2 Mounting Screws

Last two screw access holes are located under the truck and it can not be rotated out of the way. Instead, slide the screwdriver between the side frame and the truck, just behind the wheel.

Let the tool center itself in the screw head and remove the screw. If you are using a magnetized tool, you can try and lift out the screw. However, as you get close to the motor, the motor's magnet may snatch the screw and stick it to the motor. Be sure and retrieve the screw before continuing.

Repeat this for the other screw and you are done.

This concludes the screw removal. The top chassis half is now separated from the bottom chassis half. Count the screws and make sure there are a total of 16.

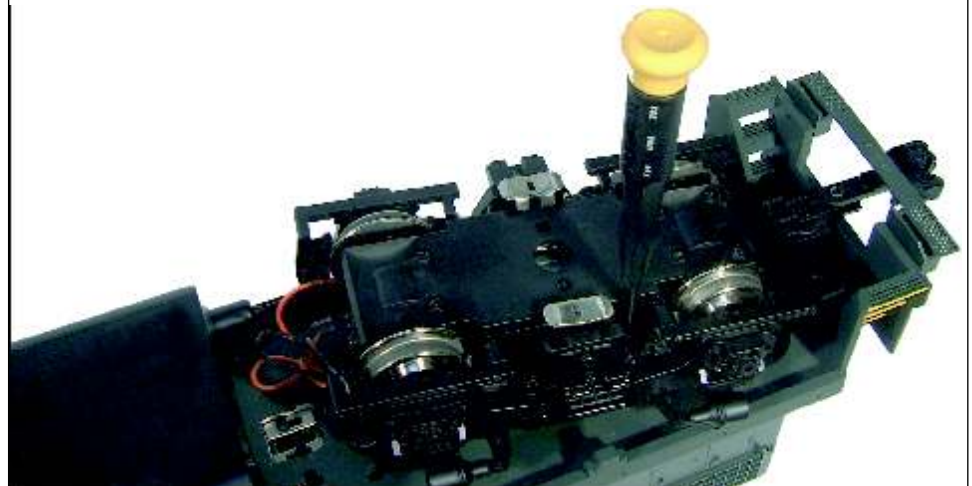

USA-Trains GP38-2 Disassembly

Separating the Top and Bottom Chassis Halves

“Gently” is the key word for this task. Starting at the back end, gently lift the top half of the chassis away from the bottom. If you feel any resistance, go back and verify all screws have been removed. The two halves should come apart easily. Place the top half on its side. Be careful of the small wires that join the two halves.

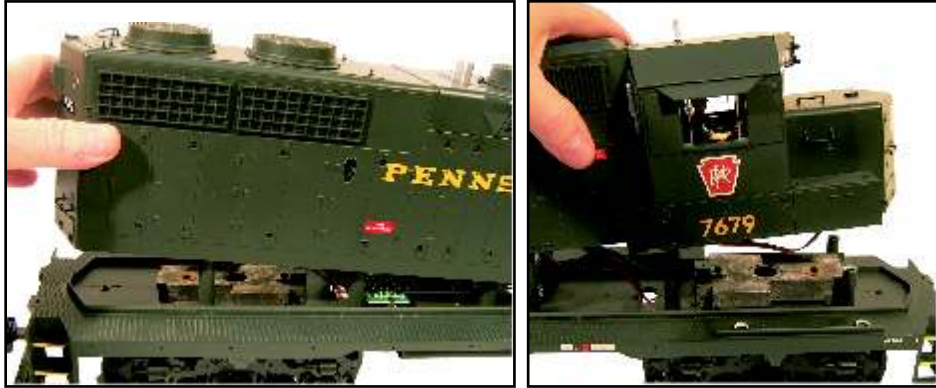

Unscrew Transistors From Front and Rear Weights

There are two transistors, each mounted to one of the lead weights. Remove the screw and the brass washer to separate them from the weights.

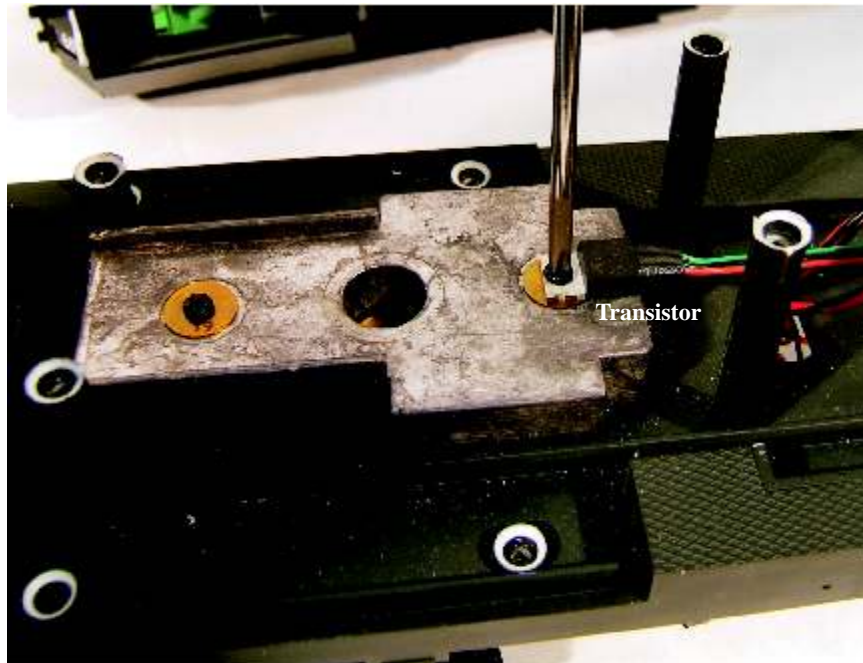

Mounting Phoenix P8 Sound Module

Remove Four More Unneeded Posts

There are four unneeded mounting posts that need to be cut flush to the floor. The posts interfere with the Drop-In decoder and the sound decoder.

The 4 posts are indicated with the yellow arrows. Use your flush cutters to remove them.

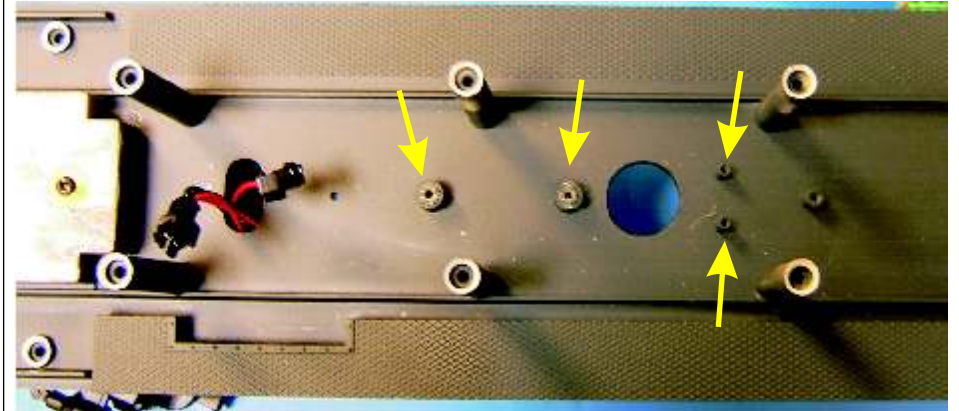

Mount The P8 Sound Module

The P8 is small and is placed in the free area between the Drop-In and the battery pack. The bottom of the P8 is uneven. Turn over the P8 and place a small piece of double-sided foam tape in the area shown. Then add one more strip across the entire unit. Orient the module as shown below. The white, right angle connector on the end of the P8 needs to face towards the rear of the locomotive.



Plug in the 6-wire P8 Cable

This Phoenix supplied cable plugs into the right angle connector on the P8 and connects to the speaker and the Drop-In decoder. Push the two brown speaker wires through the hole to get them out of the way. The cable is stiff and will not stay put. Use foam tape to hold the cable to the floor. Place a narrow strip of foam tape between the power switch and the charger jack holes. This insure the wires do not foul the jack or switch hole and are not pinched when the Drop-In is mounted.

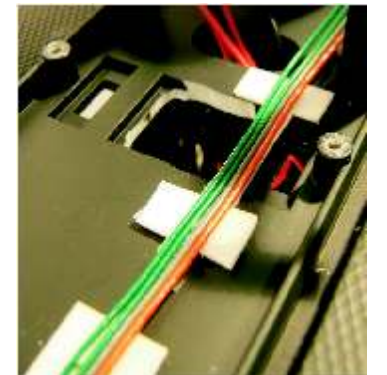
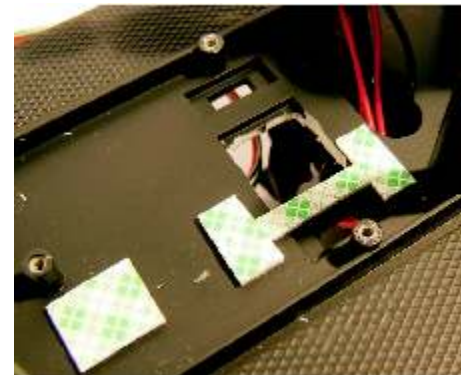

Speaker And P8 Interface Jack Mounting

In the next step, the fuel tank is fitted with a speaker and the Phoenix P8 sound module interface jack. If you are not using a sound decoder, skip the next two pages.

P8 Interface Jack Installation

The Phoenix P8 sound module uses a programming jack to connect it to a PC for editing and downloading of sound files. The programming jack is installed into the fuel tank for easy access. For fast mounting, use quick-set epoxy or hot-melt glue.

The end of the fuel tank facing the rear truck is where to drill the hole. Put the hole about half way up the tank and favoring one side. This makes it easier to plug in the programming jack. Drill a 5/16 inch hole for the jack. Remove any burrs from around the hole.

The fuel tank walls are too thick for the jack's threads so remove the nut from the jack and discard. Push the small plug and wire through the fuel tank hole. Use either epoxy or hot-melt glue to permanently mount the jack.



P8 Speaker Mounting

Newer speakers from Phoenix include a two wire plug pre-attached to the speaker. If yours is different, solder the wires to the speaker before mounting it. Hot melt glue is the quickest method to mount the speaker although some people prefer silicone adhesive which takes longer to dry. We like hot-melt glue simply because it is fast.

Center the speaker in the grill opening before gluing.

Place the hot melt glue nozzle into the speaker's corner mounting hole and squirt out a blob of glue. Slowly pull the nozzle from the hole while continuing to dispense glue. This builds up a small glue "post" that holds the speaker securely to the fuel tank. Finally, place a small amount of glue around gaps between the speaker and the mounting area for best sound reproduction.



USA-Trains GP38-2 Disassembly

Unplug All Connectors From Old Circuit Board and Remove The Board

This is relatively easy. Unplug all the connectors from the circuit board. Remove and save the little twist ties. These will be used later.

The miniature 3 and 4 wire sockets are held by friction and may seem tight. The easiest method to remove these is to grasp the group of wires near the plug. Next put your thumb on the top of the circuit board to prevent flexing. Now pull upwards while gently rocking the plug from side to side. This will release the plug from the socket.

Remove the USA-Trains speaker wires (shown on page 8) that go down through the hole in the floor. The connector and wires are not needed and may be discarded.

See below for what to do about the two smoke generators and their controller boards.

Finally, remove the 3 screws holding the main circuit board and remove it. The board is no longer needed but be sure and save the screws to mount the Drop-In decoder.

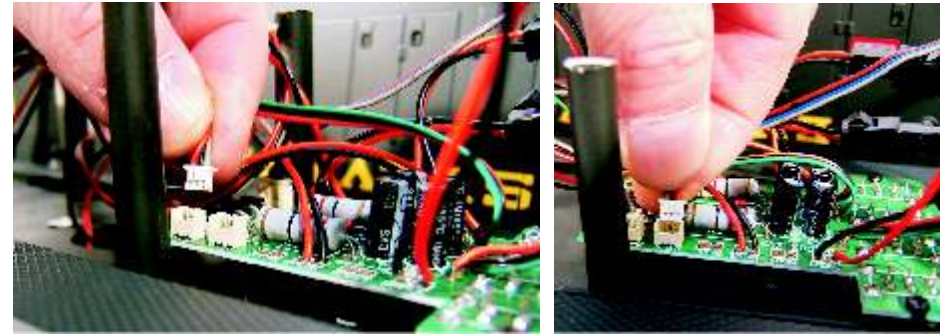

Relocate/Remove The Smoke Generator Board

This locomotive has two smoke generators and two controller circuit boards. One controller board is in the roof and the other is mounted on the chassis floor.

To make room for the sound module, battery and GP38 Drop-In decoder, you have a decision to make: get rid of one controller circuit board or mount the extra board in the shell's roof.

The easiest choice is to simply eliminate the controller board mounted on the chassis floor along with its accompanying smoke generator. That is what's shown in this installation.

Remove the smoke generator board from the chassis floor. The two screws are not needed and may be discarded.

Remove the now disconnected smoke generator from the roof. Leave in place the 2nd controller board and its smoke generator. These will be connected to the Drop-In decoder later.

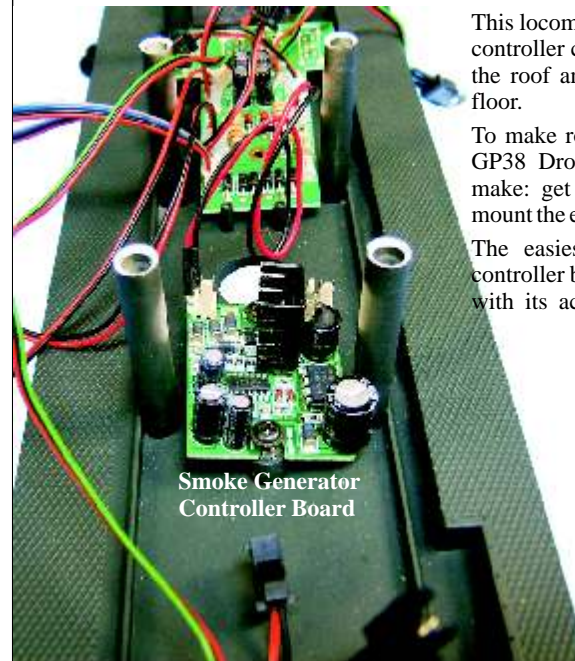

USA-Trains GP38-2 Disassembly

Removing The Rear Truck - Optional But Recommended

The rear truck and the connecting wires are in the way of the work that needs to be done to enlarge the switch holes. You don't have to remove it. However, it is real easy to nick or break the truck wires so we recommend removing it. It isn't hard.

Since the rear truck area is where the battery will be mounted, it is OK to remove and discard the weight. Remove the final screw holding the weight to the chassis. Lift off and discard. The remaining screw is what holds the truck to the chassis. Remove the screw to free the truck. So as not to lose the screw and washer, screw them back into mounting hole on top of the truck bolster. Gently pull the truck wire through the chassis hole and set the truck aside.



Enlarge Switch Hole And Mount Battery

Enlarge Switch Opening In Chassis Floor

Look at the bottom of the Drop-In board. Note the two switches and jack. The switches fit the outside switch holes in the locomotive floor. However, the area for the charging jack needs to be enlarged.

In the picture to the left, the area to be enlarged is outlined by a white box. Use a hobby knife or Dremel tool with a routing bit to enlarge this area so the jack simply drops through. The jack must not bind. When the board is mounted, also verify the chassis mounting bosses are in line with the GP38 Drop-In board's 3 mounting holes. The yellow arrows point at the 3 mounting bosses. When completed, clean away the debris and proceed on to the next step.

Reattach Rear Truck

With the hole enlarged, now is the time to reattach the rear truck. Feed the wires through the hole in the chassis floor. Do not mount the weight, it will be replaced with the battery pack in the next step.

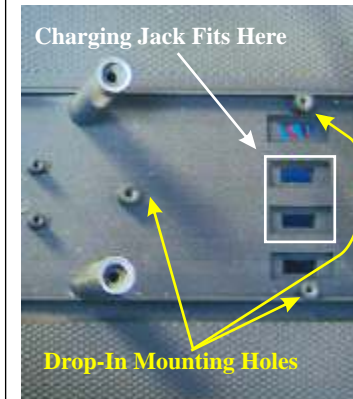

Battery Mounting

Be sure to reattach the rear truck before mounting the battery. This installation makes use of the standard CVP Lithium battery pack. The small size yet high power capacity makes for a simple installation. The battery replaces the rear weight. The battery is mounted over the rear truck on double stick foam tape.

The two plastic posts that used to hold the weight must be trimmed flush to the floor. Use a pair of flush-cutting wire cutters.

The battery is mounted to the floor using double-sided foam tape. Be sure to apply several layers of tape so the battery does not obstruct or sit on the truck mounting screw. Mount the battery between the posts onto the tape and press down firmly. For added strength, a small dab of hot melt glue can also be used, but keep the glue away from the truck mounting screw.

