

EASYDCC™ Wireless Throttle Model T9000E

Battery installation and battery type precautions	2
Throttle control locations and general descriptions	3
Setting up the T9000E throttle	4
The display and wait symbol information	5
Entering a locomotive address	6
Quick Stop, Changing Speed Steps.	7
Speed display and Function control keys	8
Restore factory defaults	9
Working with the throttle's memory	10
Controlling accessory decoders	13
Changing transmit frequency, frequency table	14
Transmission mode detailed explanation and options (scan or burst)	15
Operating tips	16
Troubleshooting, general care of the throttle	18
T9000E Cheat Sheet (suitable for lamination)	19
T9000E Command Summary and Index.	23
Warranty and repair information.	Back

WARNING - REMOVE BATTERIES

Remove all batteries from the throttle when not being used. Batteries can leak and damage and or destroy the throttle. If the batteries leak onto the throttle circuit board it can not be repaired.

Installing Batteries

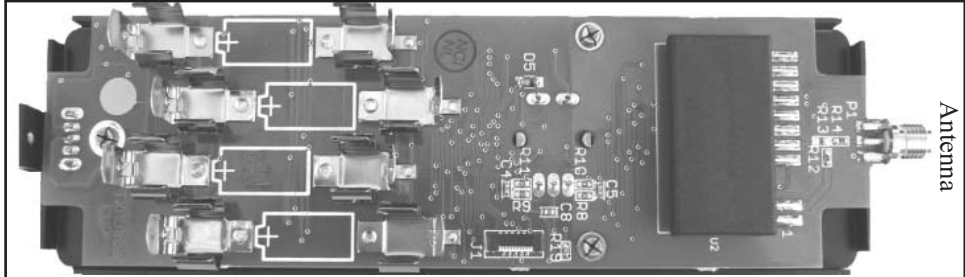

First, unscrew the antenna and set it aside. If your throttle has a shipping screw still attached at the bottom, remove it.

The internal circuit board is attached to the faceplate. So, just like pulling your foot out of a shoe, slip a fingernail into the opening at the face plate's bottom corner (the end nearest the power switch) and pull the plate up and out of the box. If the plate seems too tight, use a small screwdriver to gently pry up the plate at the bottom corner, between the plate and the box. .

The battery orientation is marked on the circuit board. Note the batteries all face the same direction with the plus end towards the bottom, away from the antenna.

The T9000E uses up to four AAA-size batteries. The throttle will operate on a single battery. However, for longest life, use 4 batteries. The longest life comes from Alkaline-type batteries. For best results, use batteries having a paper cover. The battery clips are staggered so the clips don't touch. The clips are somewhat springy and brittle. Squarely snap the batteries into the clips.

Warning: some inexpensive batteries are covered with a very thin layer of paint. This paint is easily scratched when the battery is snapped into the battery holder. If this occurs, the battery can be shorted out and the throttle will not function properly. Shorted batteries become hot. Feel them before closing up the throttle.

Slip the face plate back into the box. Make sure the antenna connector is completely seated in the hole. Screw the antenna on finger tight. Do not over tighten or you risk damaging the antenna connector. The shipping screw is not necessary.

Removing Batteries Use a dull plastic or wooden object to gently pry the batteries up and out of the holder starting from the outside and working towards the center. Do not use sharp objects or there is risk of scratching and damaging the circuit board. Do not bend the contact ends of the clips or they will break off.

Using Rechargeable Batteries Rechargeable Nicad batteries may be used along with an external charger. The newer Nickel-metal Hydrides (NiMH) cost a little more but have none of the annoying characteristics of Nicad batteries. Be sure to use at least one AAA size battery. Most Nicad chargers will charge the Nickel-metal Hydride batteries. However, for best results and the fastest recharge, always use a charger designed for the specific type and chemistry of the rechargeable battery used.

The T9000E Wireless Throttle



The liquid crystal display, LCD, should not be pushed, pressed or scratched. Excessive pushing on keys or the rotary encoder may result in image smearing. Excessive heat can temporarily cause the display to turn black. It will return to normal appearance in a few minutes after the heat source is removed.

Rotary Encoder
Speed or Scroll Control

Push Down for Direction Key

All keys, including the direction key are click style keys. Push and release them "smartly" to avoid duplicate entries. Always push and release a key unless instructed otherwise.

Show Key

Emergency stop
selectable - loco or system

Not Used
Reserved for future use

Select/Set Key

"Pound" or Enter Key

Star, Escape or Quit Key

Power Switch - Slide Type
Left is off, right is on

Setting Up The T9000E Throttle

Before putting the throttle to work on your layout, you must select and set into the throttle several options - some of which might be new to you. The setup requires a few keystrokes that take effect immediately and are remembered when the power is turned off. This section highlights the key items to set up plus provides a reference page, shown in [] brackets, for more information. These settings may be changed at any time.

SEL 1

Select Transmission Frequency [page 14]

The default frequency is 0. To change the frequency, push and release the SEL key, then push the 1 key. The antenna symbol flashes indicating you are selecting a frequency.

The available frequencies are numbered from 0 through 7. Push the desired number followed by the # key to set the transmission frequency. It will be remembered even when the power is turned off.

SHOW 5

Confirm the frequency using the key sequence SHOW 5. The display will show the antenna symbol and Fr: followed by the stored frequency number which is 3 in this example. Push * to exit SHOW mode.

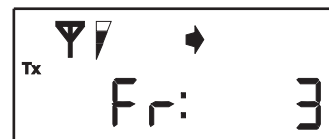

SEL 2

Select the Scan or Burst Transmission Mode [page 17]

The default mode is SCAN mode. To change the mode, push and release the SEL key, then push the 2 key. The display shows the word OPS as a reminder that you are in selecting the operating mode of the transmitter.

For **SCAN** mode, push and release the 0 key followed by the # key. You will see Scn appear momentarily in the display indicating you are in the scan transmission mode. The display will also show the initials TX as a reminder that you are in the scan mode.

For **BURST** mode, push and release the 1 key followed by the # key. You will see "Bur" appear momentarily in the display indicating you are in the burst transmission mode. The display will change to a blinking TX..

Confirm the transmission mode setting by checking whether the TX is on solid (scan) or flashing (burst).

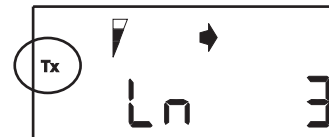

SEL 3

Select Emergency Stop Action [page 9]

The default action is to only stop the locomotive controlled by the throttle when the SPPr key is pressed. You can change this to halt the entire **EASYDCC** system.

Push SEL followed by the 3 key. The display will show ES as a reminder you are setting the emergency stop action. For the locomotive **only** to be affected, push the 0 key followed by the # key. For the entire **EASYDCC** system to be halted, push the 1 key followed by the # key.

SHOW 4

Confirm the Emergency stop setting using the key sequence SHOW 4. For this example, the selection is 0, or only the locomotive is to react to Emergency stop. Push * to exit SHOW mode.

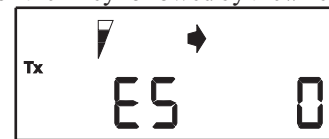

Setting Up The T9000E Throttle *continued*

SEL 0

Select Throttle ID number [page 17]

The default ID number is 63. However, every wireless throttle, old style or new style must have a unique ID number. This ID number may be any number from 1 to 99. However, if you are using Burst Mode, special rules apply to the selection of the ID number. Please see page 17 for a table of “burst-mode” IDs if you intend to use the throttle in the burst mode.

To change the ID number, push and release the SEL key followed by the 0 key. The display shows Id to indicate you are selecting the ID number. Now push the keys for the desired ID number followed by the # key. Leading zeroes are not required. The ID number is remembered even with the power off.

SHOW 3

Confirm the ID using SHOW 3. The display shows the current throttle ID number you just entered which is 8 in this example. Push * to exit SHOW.

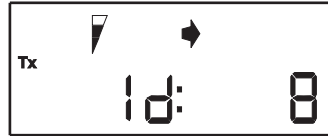

The “Normal” Or Run-Mode Display

Before jumping into lots of detail, take a look at what is called the normal run-mode display which is abbreviated to simply “normal display.” This “normal display” is the default display after turning on the throttle. It is also what you see after you conclude a command or after you push * to exit the SHOW mode.

Ln is the abbreviation for Locomotive Number which is the decoder’s address. This is the current active locomotive decoder’s address that is being controlled. If you are using consists, this will be the consist number which is typically the lead locomotive’s address. See the Command Station manual for how to build consists.

The direction setting is shown by the black arrow. A right arrow always meaning FORWARD, relative to the locomotive’s cab. A left arrow means REVERSE, relative to the cab.

The little apostrophe symbol is the speed step indicator. It has three segments that show the current speed step setting and will be explained later.

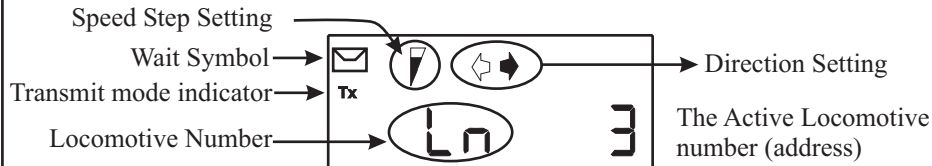

The WAIT Symbol

The WAIT Symbol

The little envelope symbol in the upper left corner of the LCD, indicates you must WAIT. It is called the WAIT symbol or icon. While is showing, do not use the throttle. This symbol will turn off after approximately 2 to 3 seconds which is your signal that the throttle is ready for use. The WAIT symbol appears after any kind of change to the throttle such as changing the locomotive address, frequency or memory recall. Do not use the throttle until the symbol has turned off.

When specific command sequences are described, the key or keys used are shown in the black banner in a white rectangle. For example, the keys # nnnn # are used, where nnnn are the one- to four numbers of the address being entered.

nnnn

Entering a Locomotive Address

This is simple. Push the # key, the address numbers and then the # key again. Entering a new address, or locomotive number always starts and ends with the # key. For the following example, the locomotive number will be 4129.

Start by pushing the # key. Notice the previous number goes away and the small colon is now blinking. Because of its small size, the blinking colon may be difficult to see.

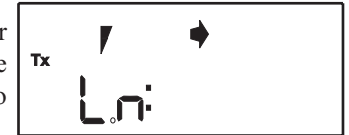

Now push the number keys, 4,1,2 and 9. The display will show each number as it is pressed, with previous numbers moving to the left. If an incorrect number is entered, just continue and enter the proper 4 digits, ; no need to start over because **only the last 4 entries** are used when the # key is pushed.

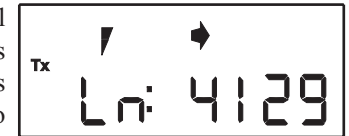

Now push the # key to tell the throttle you are finished entering numbers.

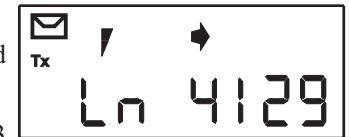

Notice the WAIT icon turns on and stays on for about 3 seconds. Do not use the throttle until the WAIT icon is off.

Once the WAIT icon is off, the new address becomes effective and the direction is set to forward. If you could see the flashing colon, you’ll notice it is off too.



Controlling Speed and Direction

Speed control is with the big knob. Turn the knob clockwise to increase the speed of the locomotive. Turn the knob counter-clockwise to decrease the speed. The speed control is a continuously turning rotary encoder. But, unlike some speed controllers, it does not use a center-off position. Turning the speed control clockwise, increases speed until the maximum value is reached. Turning the control counterclockwise, decreases speed until the minimum value is reached.

Direction control is a push switch built into the speed knob. Push down on the knob’s top and release it to change directions. Notice the direction arrow changes.

A right facing direction arrow indicates FORWARD relative to the locomotive’s cab. A left facing direction arrow indicates REVERSE direction, relative to the cab. The direction arrow does not indicate the physical direction of movement.

Quick-Stop

SPR

Depending on your initial selection for this command, pressing the SPR key will either halt the locomotive or the entire system. The default and the most commonly used selection is to stop the locomotive. Pushing the SPR key, instantly transmits the 0 speed command, to the locomotive independent of its present speed setting. This is called the “Quick-Stop” command.

Although the speed command is now 0, the locomotive may take a few moments to come to a stop depending on the decoder settings. This form of emergency stop takes a bit longer but is much less destructive to the gears and motors.

Change Number of Speed Steps

DIR

Your throttle’s rotary speed control can be set to use one of 3 different settings to change the number of rotations, or steps, from off to full speed. These are called speed steps. Setting a high number of steps provides more precise speed control for precision switching moves. A lower number allows quick and wide speed changes for mainline operations with minimal knob turning. The settings can be changed at any time; there is no change to the decoder.

There are three speed step settings from which to select: 16 steps, 32 steps or 128 steps.

For this example, the speed step setting is now 16 steps. This can be seen by noting the apostrophe symbol which is showing only a small, single tip.

Press and release # key. Now press and release the direction key. The SS in the display indicates Speed Steps.

Push one of the 3 keys listed below for the desired speed step selection. Notice that immediately following the selection, the speed step symbol changes.

The # key does not have to be pushed again. The selected speed value is shown for about 2 seconds before the display returns to the normal display.

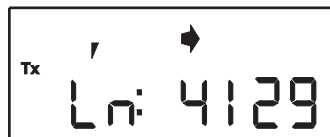

- ' 1 = 16 speed steps [one full turn]
- ▾ 2 = 32 speed steps [about 1 and 1/2 turns]
- ▾ 3 = 128 speed steps [about 6 turns]

Speed steps on the throttle are not the same as speed steps on the decoder. There are no changes made to the decoder to use the throttle’s different speed step settings and may be used with any decoder.

SHOW 0

Showing Speed Numbers

At any time, you can show the throttle’s present speed value or step number being transmitted.

SHOW 0 is the command to bring up the Speed Number display. On this display, you can see the current speed number and direction and it updates anytime you change the speed or direction.

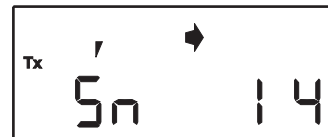

Speed numbers are nothing more than a range of numbers from 0 which is OFF, to either 16, 32, or 127 which represent full speed.



Note: When set for 128 speed steps, the highest number shown is 127.

Push * to return to the normal display. In almost all cases, the * key will cancel or terminate a command.

Quick Stop While Showing Speed Numbers

When in the SHOW SPEED mode, push the 0 key to instantly zero the transmitted speed number. Although the speed is now 0, the locomotive may take a few moments to come to a stop. This form of emergency stop takes a bit longer but is much less destructive to the gears and motors.

n

Function Keys

The T9000E throttle supports 9 functions, F0 - F8, as currently defined by the NMRA-DCC standard.

Note: It is the decoder that establishes how many functions are available and supported. Always read the decoder’s manual to determine which functions are available as well as to their options.

If your decoder uses a function higher than supported by the T9000E, it can be assigned to one of the lower function numbers. See the decoder manual for how to reassign functions to the available function keys.

Functions - F0 to F8: Each of the T9000’s number keys are assigned to the respective DCC function; the 0 key is F0, the 1 key is F1, the 2 key is assigned to F2, etc. To active a function, push the desired number key. When a function key is pressed, the function number appears on the display and when the key is release, it stays on for a couple more seconds and then the normal display reappears. Except for F2, all function controls are latching. This means that the “activate” command is sent when the key is first pushed and released. Pressing and releasing the key a second time sends the “deactivate” command.

F2 is special and is usually assigned to a horn or whistle function. Pressing and holding the F2 key activates the horn or whistle. Releasing F2 deactivates the horn or whistle.

Restore Defaults & Clear All

SEL 9

There are many settings of the throttle that are remembered, even if the power switch is turned off and the batteries are removed. However, at any time, you may force the throttle back to its original factory settings, just as you received it. When the command is issued, all memory is erased and the defaults are reloaded.

To restore the factory defaults, first push and release the SEL key and then push the 9 key. The display will be blinking the DEF 2 command and a small envelope will appear in the upper left corner. All of these symbols are to remind you that you are about to perform a reset. To abort the reset, with no changes, push the * key.

To complete restore and clear-all sequence, push the # key. The display instantly reverts back to the original default normal message of Ln 2, 32 steps and forward. The other main item that is changed is the transmit frequency which is set to 0. The table below shows the complete set of factory reset values.

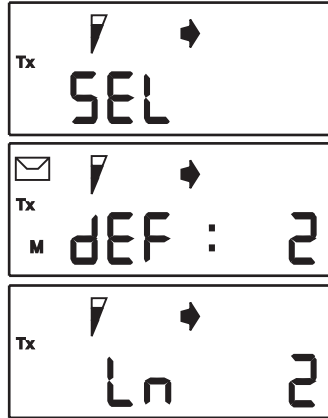

Item	Default	Item	Default
Ln Memory Slots	Cleared	Functions	All OFF
Transmit Mode	SCAN	Transmit Freq.	0
Locomotive Number	2	Speed Steps/DIR	32, FWD
E-Stop	Locomotive	ID number	63

Selecting Emergency Stop Mode

SEL 3

There are two settings for emergency stop. The default setting is for the SPPr key to only stop the locomotive address shown on the display. The other setting is allows the throttle to stop the entire system. Pushing SPPr activates the command.

Push SEL followed by the 3 key. The display will show ES as a reminder you are setting the emergency stop action.

Push 0 and # - for the locomotive only to be affected by Emergency Stop.

Push 1 and # - for the throttle to stop all locomotives and the Command Station.

Emergency Stop Activation - System Stop

SPPr

If you have selected to use the E-Stop mode that halts the entire system, the Command Station shows the message <<ALL STOP>> and the throttle shows ES 1 when SPPr is pressed. This is your clue that your throttle has initiated the system stop. Only the throttle that initiated the ALL STOP command can clear it.

Once you have pushed the SPPr key to halt the system, the other keys on the throttle are ignored. To clear ES 1 and restore normal system operation, push the SPPr key again. *Cycling throttle power will also clear ES 1.*



SHOW 1

Recalling A Locomotive From Memory

If you wish to follow the example, you must reset the throttle to factory defaults as shown on the previous page.

To show the locomotive address memory, first push the SHOW key followed by the 1 key. This is shortened to SHOW, 1. You may cancel the command at any time by pushing the * key.

To scroll through the memory, use the big knob. The starting point is always the bottom of memory which was the 1st locomotive entered. Rotate the knob clockwise to step through memory or counterclockwise to go to the bottom. You may scroll in either direction through memory from bottom to top, or top to bottom. The 1st entry is always empty and will remain so, as addresses are added. The 15th address entered will then occupy the 1st entry.

For this example, set up the throttle with the following addresses. Enter the addresses in this order using # nnnn #: 100, 1024, 52. Now key in 4129 and set the speed steps to 128. These 4 locomotives are now in memory with their current speed step setting, speed value and direction.

The first display shows 4129 which is the active locomotive since it was the last one entered. Note the speed step indicator which has all 3 segments on.



Push SHOW. Notice the M is on. This serves as a reminder that you are entering into memory mode with the next key.



Push 1. The colon and the M will flash indicating you are now viewing the 1st entry in the locomotive memory which is blank.



Rotate the speed knob one click to the right to view the 2nd location in memory. It will be 100.

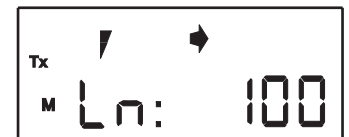

Rotate one more click to the right to see the 3rd location which is the desired locomotive address, 1024.



Push # to select the displayed address and make it the active address. Notice that the normal display has returned, the M is gone and the WAIT symbol is on.



Note that 1024 is now the active address and the speed step is set at 32.. Address 4129 and all of its settings were automatically stored in memory when 1024 was selected. Always wait until the WAIT symbol turns off before using the throttle.

SHOW 2

Deleting A Locomotive From Memory

If all 15 locomotive memory locations have been used, the T9000E automatically overwrites the oldest entry upon entry of the 16th locomotive be entered. This is automatic and you do not have to do anything to make more space.

If you have a desire to manually delete locomotives, a command has been provided for this function. You may scroll through memory and select any locomotive address for deletion. You should not delete the active locomotive. For the following example, 1024 is the active locomotive.

SHOW-2 is used to manually delete locomotives from memory. Push the SHOW key followed by the 2 key.

Notice that the E above the M is now flashing. It is a reminder that you are editing memory and all actions are permanent. At any time you can cancel the command with the * key.

For this example, lets delete locomotive 52. Use the speed control to scroll to the locomotive 52. When 52 is shown, push the # key.

Notice that the E and M are gone and that the normal display has returned. If you have been following along with this example, use SHOW 1 to confirm that 52 is gone.



SEL 4, #

Manual Update Of Locomotive Memory

The throttle's locomotive memory contains a snapshot of the speed, direction, speed-step setting and function status from the last time you either entered or recalled the locomotive from memory. If there have been any changes that you want to save to memory, you may do so at any time, using the SEL-4 command. The most common time you may want to manually update the locomotive is when there has been a change in the speed steps or function commands.

SEL-4 will update the throttle's memory with the present settings of the active locomotive. This command can be used at any time. To cancel this command push *.

Push SEL followed by the 4 key. The envelope icon plus the SLn means Save-Locomotive-number 1024 status and functions.

Push the # key to finish the command. The normal display returns but now you have an updated copy of the current function settings, speed and direction.

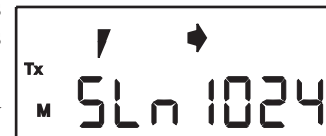

The locomotive memory for the present address is automatically updated anytime you enter a new locomotive address.

The Throttle's Ln Memory

The T9000 throttle can store the speed and direction of the previous 15 locomotives used in what is called a memory slot. A memory slot is a shorthand word to mean a section of memory used to store a locomotive number and its associated settings such as the speed value, the direction, the speed step setting and the status of all functions. If all slots are used, the oldest entry will be automatically overwritten.

Each time a new and unused address is entered with # nnnn #, the former address is automatically stored in one of the 15 memory slots. Once stored, you may recall any address from memory and instantly restore the throttle and its associate settings to exactly the same condition as when you last used the recalled address.

When scrolling through the locomotive memory that does not have 15 stored locomotives, the scroll starting point is the 15th memory slot which will be blank. This slot remains blank until the 15 locomotive is entered. At that point, the starting point for all scrolling becomes the 1st memory slot. Scrolling goes from 1st to last; it doesn't wrap around.

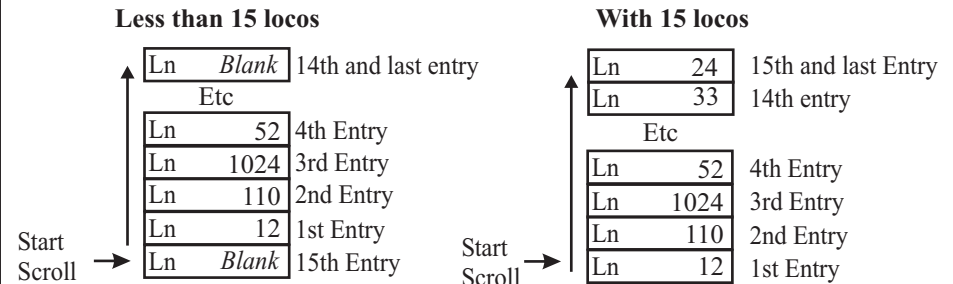

Additional Notes About The Run-Time Environment

Unlike most other wireless DCC controllers, the T9000E maintains two separate environments, one that is active and one that is stored. The run-time "environment" describes a set of conditions in which a locomotive is running or "active." Environments can be edited while stored and then recalled an made active. Once activated, all changes become effective.

The environment is always paired with a locomotive address. The environment consists of the following variables:

- Locomotive Address from 1 to 9999;
- Speed Value 0 to Speed Step Max (16 or 32 or 128)
- Direction Setting Forward or Reverse
- Speed Steps 16 or 32 or 128
- Function 0 through 8 On or Off, except for F2

Recalling a locomotive from memory, also restores its associated environment. Storing the environment is usually done automatically. However, if you make a change in one of these settings, you can force a manual update of the active locomotive's memory by using the SEL 4 command (see page 9).

Accessory Decoder Control

SEL 5

Accessory decoders may be controlled from the T9000E. Due to memory constraints, the allowed address range is 1 to 99. Accessory decoders are commonly used to control turnouts, layout lighting and other stationary functions.

Like locomotive decoders, accessory decoders have addresses and functions which may be controlled and programmed. Accessory addresses are different from locomotive addresses. You can have a locomotive address 28 and an accessory address 28 without any interference

Selecting and controlling accessory decoders is easy and you can still control your locomotive's speed and direction while throwing turnouts.

Push and release **SEL 5** to bring up the accessory decoder control display. Acc is the abbreviation for **Accessory**. At this point you will enter the address of the accessory decoder. For this example, lets use 28.



Push and release # 2 8 #. Notice that when you push the first #, the display changes to "Adr" show an address is to be entered. When the ending # is pushed, two icons, F1 and F3 appear above the address. These are small and will be flashing near the upper right corner.



The flashing F1 and F3 remind you that the "1" key and the "3" key are used to control turnouts and/or on-off effects such as lighting effects.



F1 is used to throw turnouts REVERSE or turn lights OFF. F3 is used to throw turnouts NORMAL or turn lights on. The appropriate icon, F1 or F3, will turn on solid when the key is pressed. The turnout direction is not remembered.

Addition Tips When Controlling Accessory Decoders

During the time you are controlling turnouts, the speed and direction controls will continue to operate. However, locomotive functions are not available. Note that changing directions will start the F1/F3 icons flashing again which is OK. The throttle does not remember which direction the turnout was thrown.

Once you have finished with the decoder address, you may enter a new address starting with the # key. There is no need to push SEL 5 again.

Terminate or exit this mode and return to the normal display by pushing the * key.

If you are using CVP's accessory decoders, the address is actually the "output" number which is in the range of 1 to 99. These numbers are not the same as locomotive numbers. You may have an accessory decoder with output number 1 and a locomotive number 1. There will be no conflict.

Your installation and wiring of the switch machines will determine the actual direction the switch throws. If a turnout throws the wrong direction reverse the two wires going to the turnout.

Accessory Decoder activation commands are transmitted once. If the transmission is jammed or garbled, the switch may not throw. However, you can simply push the same key again to retransmit the activation command.

Replace Battery Indicator

When the batteries have reached their final few minutes of charge, the low battery icon turns on. You only have a few minutes remaining before the batteries are completely exhausted and it is possible for the throttle to cause unexpected operation during this time. To prevent loss of control, bring all operating locomotives controlled by this throttle to a stop as soon as possible.

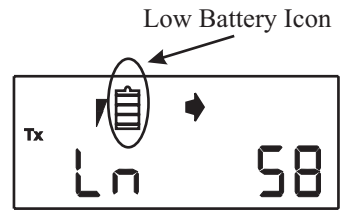

Once all locomotives have been stopped, turn off the throttle and replace the batteries.

SHOW 9

Show Software Version Number

SHOW 9 causes the platform and software version number to be displayed.



9000E is the throttle platform and 1.0 is the software version number. Your version number may be different.

Push * to return to the normal display.

Changing The Transmit Frequency

SEL 1

Each wireless throttle must be on a unique frequency so as not to jam other throttles. When in SCAN mode, any unused frequency can be used. There are 8 standard frequencies available for selection, numbered 0 to 7. The frequency can be changed at any time. If in BURST mode, frequencies 0-6 may be used. Do not use frequency 7.

Push SEL and then 1. The antenna icon will start flashing and the default frequency of 0 is shown. The table below shows the 8 standard frequencies and their number.



Push any number from 0 to 7. For this example, frequency 4 will be selected. To confirm the new frequency, push #. The change takes effect immediately.



The following frequencies are available on the T9000E throttle using the SEL 1 command. Note that frequency 7 is not to be used if the throttle is in the burst mode.

Frequency Number	Frequency	Scan	Burst
0	903.37 MHz	Yes	Yes
1	906.37 MHz	Yes	Yes
2	907.87 MHz	Yes	Yes
3	909.37 MHz	Yes	Yes
4	912.37 MHz	Yes	Yes
5	915.37 MHz	Yes	Yes
6	919.87 MHz	Yes	Yes
7	921.37 MHz	Yes	NO

Your T900E throttle supports two forms of data transmission, Scan and Burst. When there are fewer than 8 throttles, the scan mode is best. When you need to use more than 8 throttles, or you have some frequencies that are experiencing jamming problems, burst mode offers some benefits. All of throttle features are the same.

You can switch between modes at any time. The radio receiver/basestation must match the throttle setting. Please see the manual that came with your wireless receiver for additional usage tips.

Scan mode is the most commonly used mode when there are no more than 8 throttles in use. Each throttle has its own dedicated frequency and transmits continuously. This mode provides the fastest system response time and can not be jammed by any other throttle. The benefits are fast response time, no time delay, and no interference from other throttles.

Burst mode allows up to 8 throttles to share a single, specific frequency. The selected frequency is set into the radio receiver and it stays on this frequency, processing all throttles using it. When the throttle is set for burst mode, it turns on its transmitter for a short moment and “bursts” out the data. It then turns off the transmitter and waits fixed amount of time before bursting out again. During the quiet time, another throttle can burst out its data. However, there is always a chance that two throttles will turn on and burst at the same time and jam each other. The jamming can cause delays and slower response time. The T9000E has an improved burst algorithm that provides much better response time compared to the older RF1300 and TX904 designs. Keep in mind that as more throttles are added, the chances of one or more throttles being occasionally jammed goes up.

You may use any ID on the throttle when in scan mode. But, **when in burst mode**, each throttle should be given the specified IDs and in the sequence shown. These IDs have been selected to provide the least amount of jamming and interference especially when more than 5 throttles are in use.

First T9000E	ID 13	Fifth T9000E	ID 5
Second T9000E	ID 10	Sixth T9000E	ID 19
Third T9000E	ID 4	Seventh T9000E	ID 3
Fourth T9000E	ID 12	Eighth T9000E	ID 22

Summary of the Two Transmission Modes

Factor	Scan	Burst with 4 throttles	Burst with 8 throttles
Max # throttles in use	8 (w/1 rcvr)	28 (w/7 receivers)	56 (w/7 receivers)
Response Delay	Shortest	Longer	Longest
Allowed Frequencies	0-7	0-6	0-6
ID allowed	Any	Select from Table	Select From table

If using the T9000E with the Atlas/Lenz System, the highest allowed ID number is 31. Be sure to use an ID number within the range of 1 to 31 for the Atlas/Lenz system. Also, make sure that no two devices on the Atlas/Lenz ExpressNet bus have duplicate ID numbers and that none of the reserved ID numbers are used.

The T9000E Throttle operates in an unlicensed band shared by many other transmitters. These transmitters can and will create interference, intermittent throttle operation or complete failure of one or more of your throttle’s 8 frequencies. The sources of these external interfering signals can be from your own home or from adjacent homes and businesses or noisy electrical motors including your locomotive.



Interfering Transmitters. Here's a list of devices known to have caused interference to the throttle: other throttles on the same frequency, wireless devices attached to computers, TV remote controls, cordless telephones, alarm systems, baby monitors, unlicensed personal communication devices, lawn sprinkler controllers, remote starter switches, cordless light switches, outdoor lighting controllers, toys, wireless headphones, and games.

If you find a strong interfering signal on one or more of your frequencies, don’t use those frequencies; pick a different frequency and try it..

Antenna Care. Antenna should be finger tight. It should never be loose. Never operate the T9000E without the antenna. Keep the antenna away from metal objects. and don’t place your hand around the antenna.

Use Fresh Batteries. Weak batteries can affect the transmission range. When the weak battery warning indicator turns on, replace the batteries as soon as practical.

One Throttle per Frequency In Scan Mode. Do not have two throttles on the same frequency (except if in burst mode). They will jam each other and neither will work properly. Only one throttle may be on a frequency at one time. The throttle should be labeled with its frequency number.

Wait for the  to turn off. Teach operators to not use the throttle until the little envelope symbol, which is the WAIT icon, is turned off. Attempting to use the throttle can result in unpredictable operation. Please wait for the  symbol to turn off before using the throttle.

Compatibility with RF1300 and TX904

The T9000E works alongside the older RF1300 and TX904 wireless throttles without any changes or modifications to the older units. Do make sure that all throttles are given a unique ID number. Also make sure the throttles are on appropriate frequencies for their transmission mode setting. Make sure to have the latest software in the older throttles.

Burst mode in the T9000E works much better than the burst mode in the RF1300 and TX904 as long as you use the recommended burst ID numbers in the T9000E. The best burst operation occurs when only T9000E throttles are used and are not mixed with the older wireless throttles on the same receiver. If using multiple receivers, consider assigning the T9000E throttles to an exclusive receiver.

Symptoms of burst mode jamming are slow or sluggish response, and very long times for new addresses to be recognized by the command station. If this situation occurs, reduce the number of throttles sharing a single frequency and add more receivers.

Operating Tips and Techniques

Using a lanyard protects the throttle from drops. The 4-40 shipping screw has a matching 4-40 nut permanently mounted on the faceplate. This nut makes a convenient point to attach a 4-40 threaded screw to which a simple lanyard can be attached. Lanyards are usually found in office supply stores. If you attend railroad or trade show conventions, lanyards are often given away with name badges. Next time you find some, ask for a few extras.

Beware of other transmitters. There is a long list of interfering transmitters that can interfere or jam the T9000E. See the section called “Tips for Best Transmission Range” for more information.

Take advantage of different speed step settings. The T9000E has three different speed resolutions that control how many rotations from stop to full speed. At any time you may change the speed steps. For example, when executing slow speed switching in a yard, use the 128 speed step setting for the finest control. If out on the main, the 16 or 32 speed step setting is more than adequate.

The decoder’s speed step setting is independent of the throttle setting and is not changed when the throttle’s speed step setting is changed. The change takes effect immediately.

The default locomotive address 2 is not automatically placed into memory after restoring factory defaults with the SEL 9 key. If you have a real locomotive with address 2, enter it with the usual # 2 # to make it active AND to store it in memory.

Leading zeroes are not needed. A locomotive addresses can be in the range of 1 to 9999. And changing the throttle address can be done at any time and without turning off power. The address change becomes available when the WAIT symbol turns off. The previously used address is stored in memory and may be recalled at any time.

Address 0 is not allowed. If zero is entered, it will be ignored and the current address will remain unchanged.

Throttle speed is always reset to zero after power is turned off and back on. In other words, the rotary speed control is reset to 0 independent its setting before power was turned off. Also, when power is turned on, the default direction setting is always forward.

The last locomotive address used is restored when power is turned on. To change to another locomotive address, either key in the address or select it from memory.

All non-zero speed values in memory are reset to zero when power is turned on. If you had a locomotive with a non-zero speed value in memory and turned off the power, the throttle will instantly zero the speed and set the direction to forward.

Burst mode operation works best if the T9000E throttle has its own, dedicated receiver. If using older wireless throttles and multiple receivers, consider assigning the T9000E throttles to an exclusive receiver.

Troubleshooting

Remember B - A - I - M

If your T9000E doesn’t seem to be working, or is working poorly, use the acronym **BAIM** as a quick checklist. Don’t forget that the placement of the radio receiver has a large impact on the reception. See the manual that came with your wireless receiver for more details on receiver replacement. And finally, jamming can come from external transmitters can be intermittent or continuous. Be aware that intermittent operation of a single throttle may be due to jamming from an external source.

B = Battery

Are the batteries oriented properly? Double check orientation. A reversed battery will short out its adjacent battery and quickly run both down. The two batteries will also become hot to the touch. If this occurs, remove and discard all batteries and install fresh batteries.

Are the batteries weak or dead? If the display is blank, replace the batteries.

A = Address

Look at the display. Did you key in the correct address. Sometimes a key will give two entries instead of one or it was hit so quickly that it was missed. Key in the correct address again. Push each key firmly and smartly. Don’t press and hold a key when entering addresses. Just push and release each key, one at a time.

I = ID number

Check the ID number. Is it correct and not a duplicate?

M = Mode

Check the transmission mode. Did you or somebody else change the mode? If you are using burst mode and a throttle has not been set for burst mode, it will jam all other burst mode throttles. If in burst mode, make sure you have selected the proper throttle IDs.

Care of Your Throttle

Your throttle is designed for years of trouble free use. Follow these simple guidelines to protect and extend your throttle’s life.

Remove the batteries if the throttle is not to be used for several weeks. A leaky battery can destroy the T9000. And there is no warranty coverage for a leaky battery.

Do not attempt to recharge alkaline batteries.

Keep the throttle dry. Do not expose it to moisture, steam, chemical vapors or rain.

Do not expose it or store it in high temperature locations.

Clean the face plate and display with a damp cloth only. Do not use solvents or cleaning solutions of any kind.

Do not abuse the speed control. It can be damaged through excessive lateral or vertical force.

Use a lanyard to protect against drops. See page 17.

Do not place heavy objects on the throttle.



Do not bend the antenna. It is flexible near the tip but not near the connector.

EASYDCC T9000 Commands

Add/Run Loco (address nnnn)	# nnnn #
Set Speed Steps (16,32,128)	#, DIR, 1/2/3
Quick Loco Stop	SPr
Functions 0-8	0-8
Show Speed/direction	SHOW 0
Quick Stop	0
Exit show speed	*
Select Memory Loco	SHOW 1, #
Store Ln Run Changes	SEL 4
Delete Memory Loco	SHOW 2, #
Cancel/Escape	*

Accessory Control	SEL 5
Enter address (1-99)	#, nn, #
F1	Off, Reverse
F3	On, Normal
Exit, quit	*

Select Standard Freq (0-7)	SEL 1, n, #
Select SCAN Mode	SEL 2, 0
Select BURST Mode	SEL 2, 1
Reset to factory defaults	SEL 9, #
Show software Revision	SHOW 9
Select ID (1-99)	SEL 0, #
Select ESTOP=Loco	SEL 3, 0
Select ESTOP=System	SEL 3, 1
Show ID	SHOW 3
Show ESTOP mode	SHOW 4
Show Transmit Freq	SHOW 5

TX symbol solid	SCAN
TX symbol flashing	BURST
Speed Steps: 16  32  128 	

T9000
Cheat Sheet on
Opposite Side

T9000 Command Summary and Reference

# nnnn #	Enter or recall from memory, locomotive number, Ln	6
# DIR, n	Set Speed Steps	7
n = 1	14 speed steps	
n = 2	28 speed steps	
n = 3	128 speed steps	
DIR	Change direction of locomotive.....	6
n	Control function n where n is 0 to 9	8
SHOW 0, n	Show speed number and direction	8
n = 0	Set speed to 0	
SHOW 1, x	Show memory and select any locomotive, Ln	10
x = DIR	Show stored speed and direction of displayed Ln	
SHOW 2, x	Show memory and delete locomotive, Ln, direction	11
x = #	Delete displayed Ln	
x = DIR	Show stored speed and direction of displayed Ln	
SHOW 3	Show ID number (1 to 99)	5
SHOW 4	Show emergency-stop mode (0 = Loco, 1 = System)	4
SHOW 5	Show transmission frequency number (0 to 7)	4
SHOW 9	Show platform and software version number	14
OPR, n	Duplicates two of the SHOW commands otherwise, not used	na
n = 1	Same as SHOW 1	
n = 2	Same as SHOW 2	
SPR	Quick Stop.....	7,9
SEL 0, n	Set ID number where n is from 1 to 99.....	4,15
SEL 1, n	Set transmit frequency - Standard - where n can be from 0 to 7.....	14
SEL 2, n	Select transmission mode, scan or burst	15
n = 0	Scan mode - continuous transmission, dedicated frequency	
n = 1	Burst mode - intermittent transmission, shared frequency	
SEL 3, n	Set Emergency Stop Operations	9
n = 0	Stop only the active locomotive	
n = 1	Stop the entire EasyDCC System	
SEL 4, #	Update displayed Ln's memory	11
SEL 5	Enter Accessory Decoder Control.....	13
# nn #	n = accessory decoder address from 1 to 99	
1:	1 = Reverse/Off	
2:	2 = Forward/On	
SEL 9, #	Clear memory and reset T9000 to factory defaults.....	9

Warranty Information

This warranty covers substantial defects in materials and workmanship in the T9000E Wireless Throttle.

What This Warranty Does Not Cover

This warranty does not cover any problems which result from improper operation, leaking batteries, modifications or damage caused by exposure to moisture and rain. Normal wear and tear are also not covered. Items subject to wear and tear include battery clips, the removable antenna, antenna mounts, and the speed control.

Leaky Batteries Will Destroy The Throttle

Always remove batteries from an unused throttle. If the battery leaks on to the circuit board, the throttle suffer damage that can not be replaced. The warranty does not cover leaky batteries.

Warranty Duration

The coverage of this warranty lasts for 1 year. After this period, standard repair rates apply.

Need Help?

If you have questions or need help, use the phone number below. In some cases, we will busy helping other customers or it will be after hours. Please leave a message. Be sure to leave both daytime and evening numbers along with your city and state. Have your manual and equipment nearby before you call.

Do not send items to us for repair without first obtaining authorization. In many cases, problems are easily solved via phone or email without the need or expense to return items to us. **If we authorize** and request you to return an item, be sure to mark the "Return Material Authorization" (RMA) number on the outside of the box. **Items sent without an RMA will be refused and returned at your expense.** You are responsible for all shipping charges.

CVP Products 415 N. Bowser, Ste. #101, Richardson, TX 75081



Your T9000E throttle is carefully designed and certified unlicensed low-power transmitter. The FCC ID label and the compliance label serves to show the FCC has authorized this transmitter. This transmitter has been tested and found to comply with the limits for a Class B digital device, pursuant to part 15 of the FCC rules. These limits are designed to provide reasonable protection against harmful interference in a residential installation. This equipment uses and can radiate radio frequency energy and, if not installed and used in accordance with the instructions, may cause harmful interference to radio communications. However, there is no guarantee that interference will not occur in a particular installation. If this equipment does cause harmful interference to radio or TV reception, which can be determined by turning the equipment off and on, the user is encouraged to try to correct the interference by one or more of the following measures.

- Reorient or relocate the receiving antenna;
- Increase the separation between the T9000E transmitter and the TV/radio receiver.

FCC Licence ID: OKWTX904

CVP Products P.O. Box 835772 Richardson, TX 75083-5772
972-238-9966 10AM- 4PM Central Time, Weekdays www.cvpusa.com